

902-757 Corkscrew Aztec Climber

Page 1
Rev. 04/9/2010

IMPORTANT

PLEASE READ THESE INSTRUCTIONS BEFORE COMMENCING ASSEMBLY. Please retain this instruction sheet in your files. It contains important replacement parts information. All equipment must be installed in accordance with these instructions. It is important to use and maintain all public playground equipment properly. Playground equipment, which is improperly maintained, can cause serious injury. Periodical inspections, maintenance, repair and/or replacement of damaged parts is necessary for safe operation of equipment. Appropriate publications, available at no charge, from the Consumer Product Safety Commission, include "A Handbook for Public Playground Safety". You can receive your free copy by calling 1-301-504-0708.



		<u>PACKING LIST</u>		<u>HARDWARE BOX</u>
1	CTN	Hardware Box	36	M10 x 60 Hex Bolts
2	PLT	Aztec Plastic Panels	36	M10 Nylon Insert Lock Nuts
		Vertical Connecting Poles	72	Flat Washers
		Horizontal Connecting Poles	72	Bolt Caps
		Aztec Panel Ground Anchors	1	Warning Label
			1	SportsPlay Label

2 SKIDS

Weight 1,141#

Class 70

GENERAL FOOTING RECOMMENDATIONS:

Diameter and depth of footings illustrated are satisfactory in most applications for pipe sizes up to 4" diameter. Varying soil & climatic conditions may require deeper and heavier footings in some areas. Check local building codes.

Detail:

Post Footing Detail (TOP DRAWING) & Ground Metal Anchor Detail (Bottom)

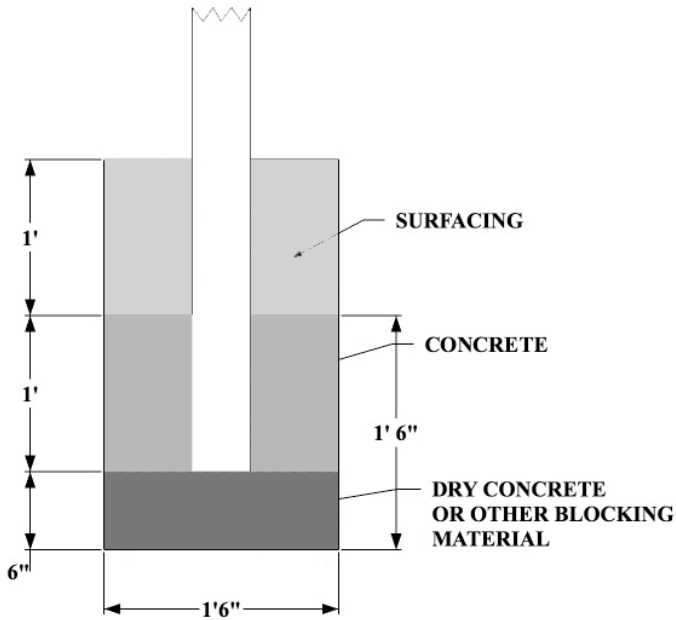

GROUND ANCHOR FOOTING CUTAWAY

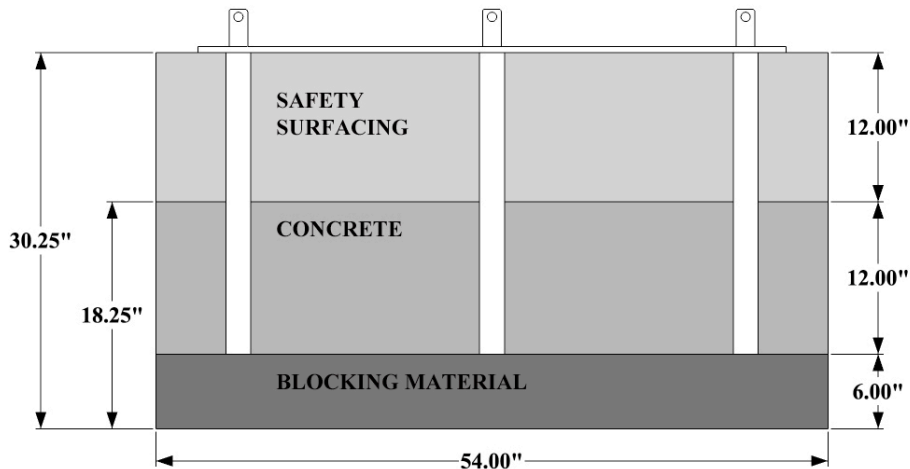

* If resilient surfacing is to be less than 12", then additional pipe should be put in concrete to maintain proper finish grade for equipment.

Footing Layout (Close up of the ends)

MAIN POST FOOTING LAYOUT

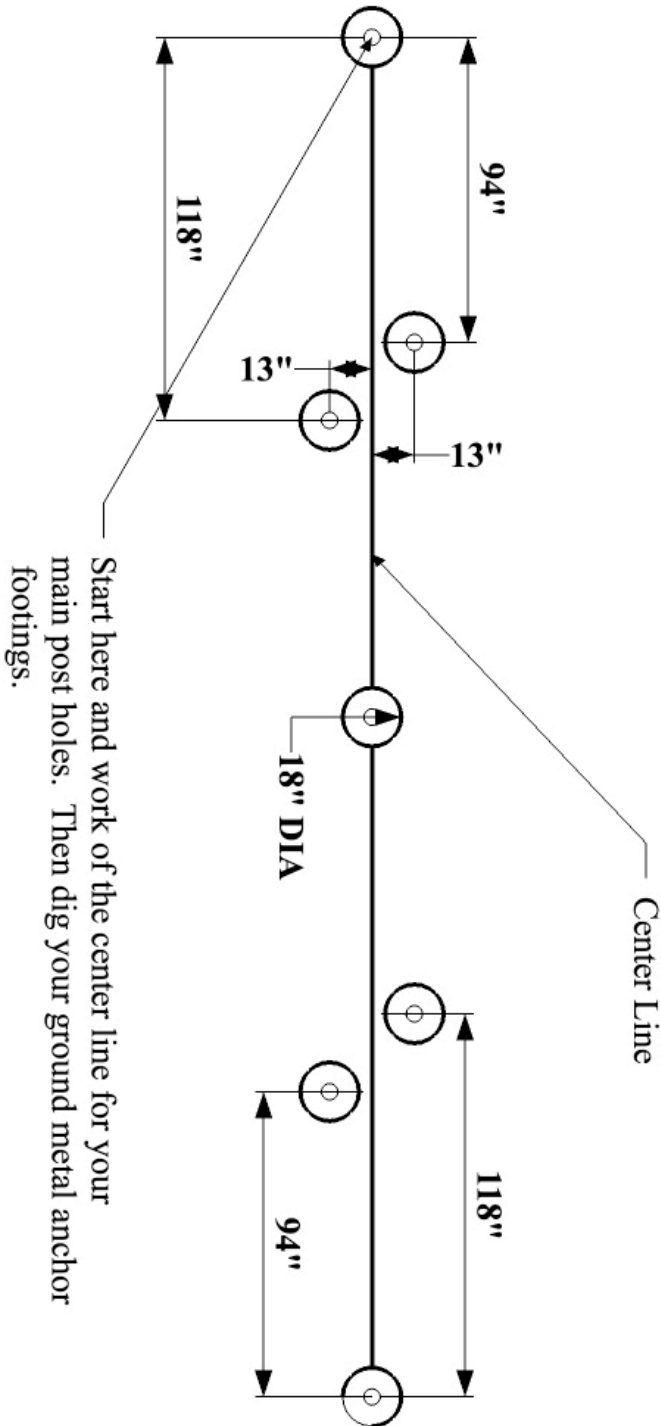

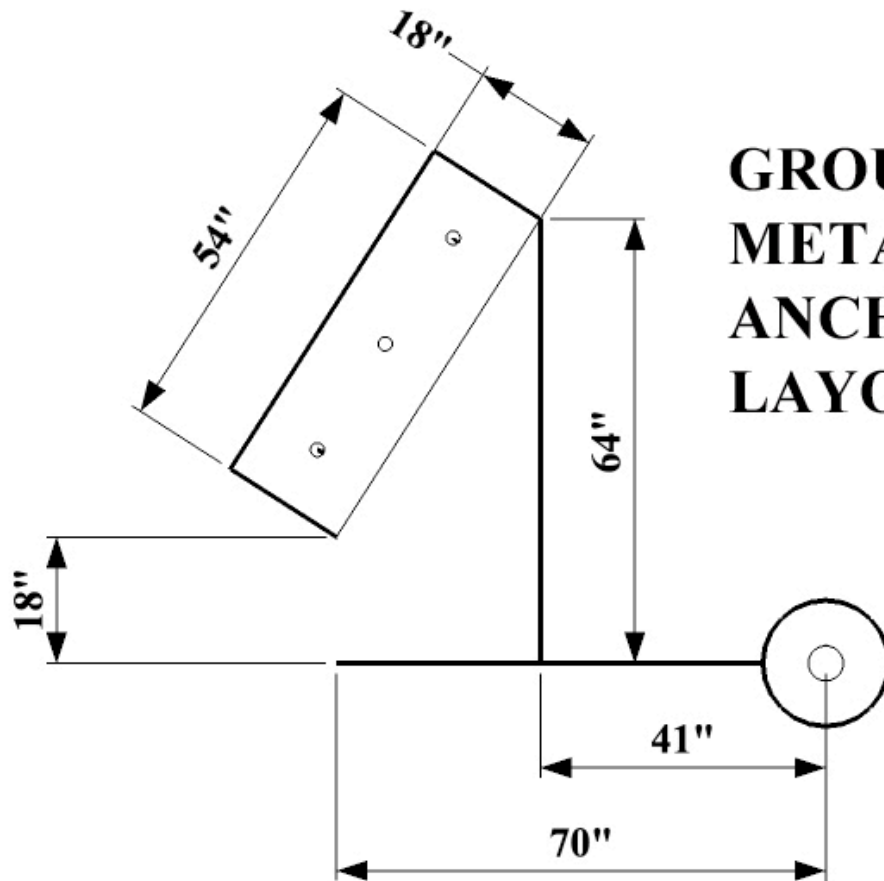

**GROUND
METAL
ANCHOR &
LAYOUT**

902-757 Corkscrew Aztec Climber

Page 6
Rev. 04/9/2010

Use Zone

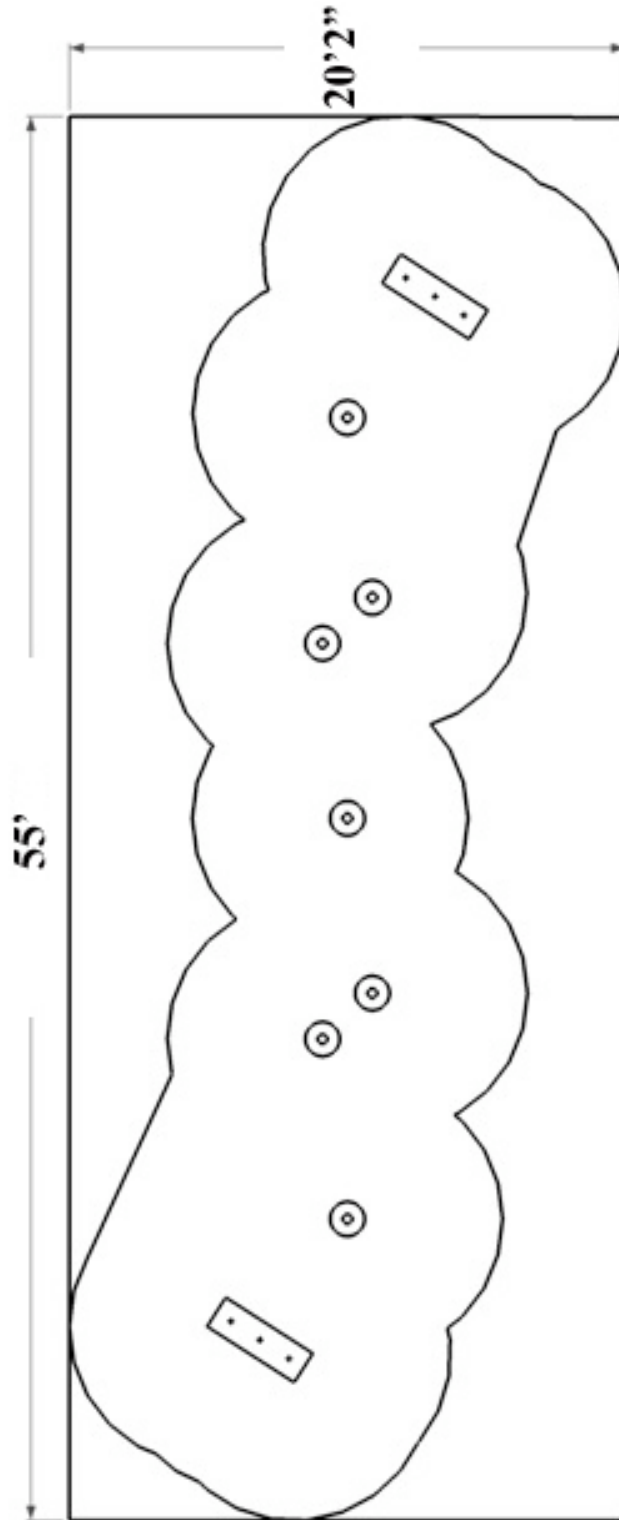

902-757 Corkscrew Aztec Climber

Page 7

Rev. 04/9/2010

GENERAL MAINTENANCE INSTRUCTIONS:

Check MONTHLY for loose bolts, damaged or broken parts. Tighten and/or replace immediately. Replace any parts that show a reduction of 25% from the original size.

GENERAL ASSEMBLY INSTRUCTIONS:

Check all the parts and hardware with the packing list to be sure you have received everything needed to assemble this product. CONTACT YOUR LOCAL DISTRIBUTOR WITH NOTIFICATION OF ANY MISSING OR DAMAGED PARTS.

Contact must be made within ten days of receipt of your order.

Only hand-tighten nuts & bolts on initial assembly. Final tightening should be done EVENLY after final assembly when unit has been plumbed & leveled.

After assembly is complete, ANY ENDS OF BOLTS PROTRUDING BEYOND NUTS SHOULD BE CUT OFF AND/OR PEENED OVER TO REMOVE ANY SHARP EDGES. Go over entire unit to file smooth any sharp edges or projections that may have been caused by rough handling in shipping or installation.

ASSEMBLY AND INSTALLATION:

NOTE: All threaded ends of bolts protruding beyond nuts must be cut off and/or peened to eliminate sharp edges. No more than two threads should extend beyond face of nut. All washers, "T" nuts, and other fastener hardware used on round pipe or tubing must be hammered down to conform to the curved underlying surface to eliminate catch points. All Bolts must be covered with Bolt Caps and Covers

STEP #1: Using all of the Footing Diagrams as a guide, mark and dig footing holes starting with the holes for the main posts. Add concrete only after the entire unit is assembled. Total footing depth including the surfacing is 2' 6". If you use 12" of surfacing than the actual hole will be 1' 6". Footing depths vary by location. You must check local building codes for requirements. Should the building code require a deeper footing the actual post depth cannot change because it would throw off the overall height of the equipment. Add a brick or solid object to the deeper hole and keep the post at the proper height.

STEP #2: Attach the Aztec Plastic Panel to the Aztec Panel Ground Anchor by placing the Plastic Panels over the tabs of Ground Anchors.
Note: The King Figure must be on the lower left.

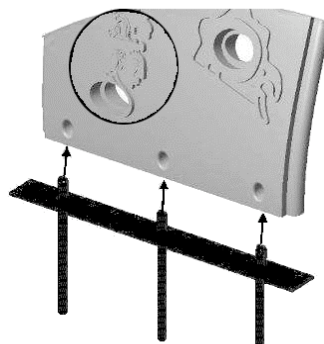

STEP #3: Secure the Plastic Panel to the Ground Anchor by placing a bolt and washer in a bolt cap and pushing through the aligned hole in the Plastic Panel and Ground Anchor. Fasten by placing a washer and nut in a second bolt cap and securing to the bolt from the opposite side. Repeat this process for the other two holes.

STEP #4: Repeat Steps 1, 2 and 3 with other Ground Anchor and Plastic Panel.

STEP #5: Attach the other side of the Aztec Plastic Panel to the Vertical Connecting Post utilizing the same fastening technique as was used in steps 1 and 2.

Note: The Dragon Figure must be at the top of the Panel

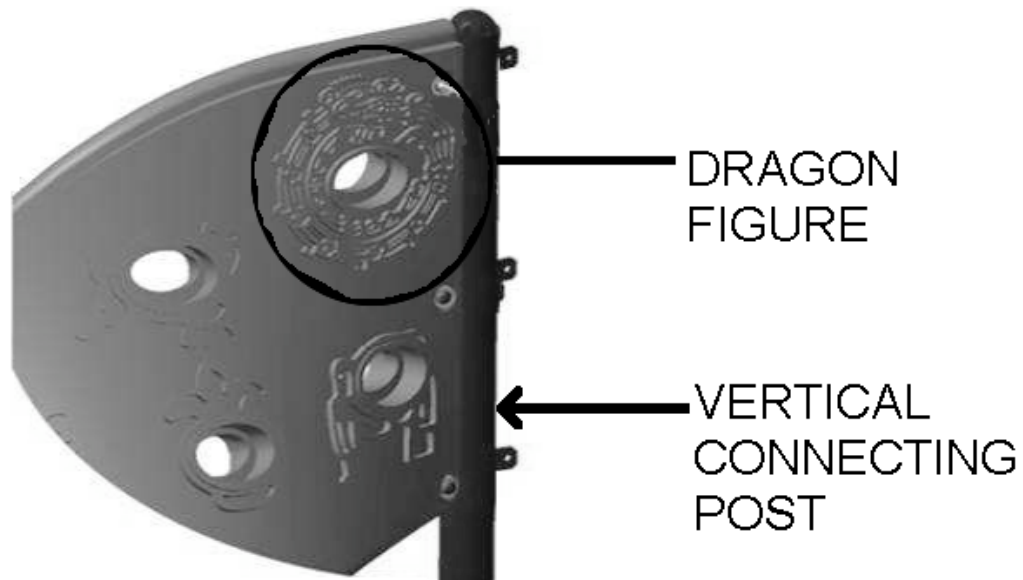

STEP #6: Spot area for Horizontal Connecting Post. Area should resemble picture below. **Approximate height of the hole on lower tab on the main post to the top of the safety surfacing is 47"**

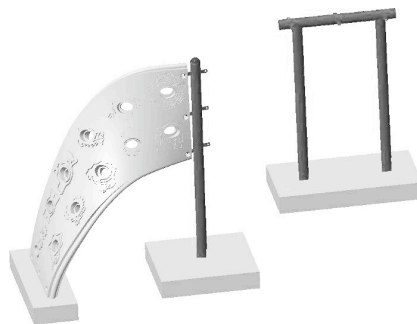

STEP #7: Attach Aztec Plastic Panel to Vertical Connecting Post and in turn to Horizontal Connecting Post. Secure using same technique as before.

Note: The Dragon Figure must face upwards as shown below

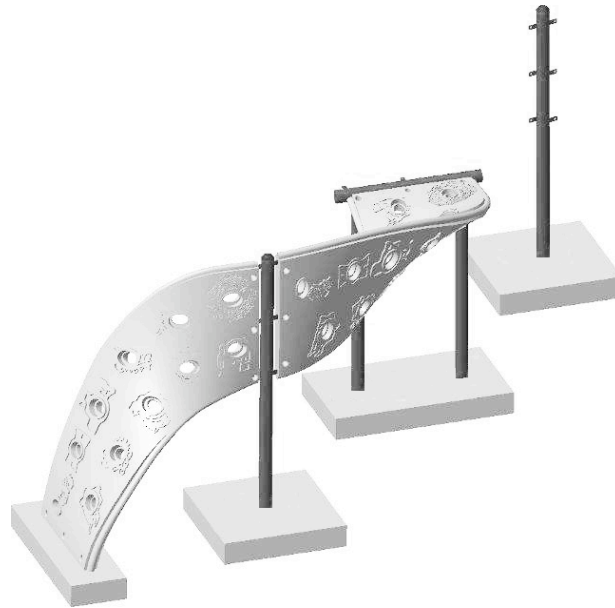

STEP #8: Using the same technique as was used in the previous step, attach the remaining Aztec Plastic Panel to the Vertical Connecting Post as well as the Horizontal Connecting Post. Secure using bolt caps, bolts, washers and nuts.

Note: The Dragon Figures must face upwards as shown below



STEP #9: Plumb & level entire unit. Fully snug all fasteners. Push bolt caps in to bolt covers. Pour Concrete with slight dome to ensure proper drainage. Wait 48 hours before removing braces. Install resilient safety surfacing.

STEP #10: Attach Warning Label and Manufacturer's Identification Label to a clean surface. The Labels should be attached in a location where they are clearly visible and legible and away from normal hand and foot placement areas. The Labels must be replaced if they become illegible, destroyed or removed. Contact your distributor for replacement Labels.

Bolt Cap Detail

